



**DentalDeal**

## OPERATION INSTRUCTION

**VRN-A8**  
ULTRASONIC SCALER

[www.dentaldeal.ca](http://www.dentaldeal.ca)

## CONTENT

1. Products overview.....	4	3.4 Clean of tips, endochuck, wrench and endo wrench .....	21
1.1 Overview.....	4	3.5 Troubleshooting and notes.....	21
1.2 Product components.....	5	3.6 Troubleshooting for the electric-magnetic valve.....	24
1.3 Product applicable scope.....	5	4. Precaution.....	25
1.4 The technical specification.....	5	4.1 Notice when using equipment.....	25
1.5 Components and function.....	6	4.2 Contraindication.....	27
2. Production function and operation.....	13	4.3 Storage and maintenance.....	27
2.1 Scaling function.....	13	4.4 Transportation.....	27
2.2 Endodontics function.....	16	5. Packing list.....	28
2.3 Wireless control foot pedal function.....	17	6. After-sale Service.....	29
2.4 Automatic water supply system .....	18	7. Symbol instruction.....	29
3. Sterilization and maintenance.....	19	8. Environmental Protection.....	30
3.1 Sterilization of detachable handpiece.....	19	9. Manufacturer 's right.....	30
3.2 Sterilization of tips and endochuck.....	20	10. EMC Declaration .....	31
3.3 Sterilization of wrench and endo wrench.....	20		

## Copyright and statement

Copyright © Guilin Veirun Medical Technology Co., Ltd.

Congratulations to become valued customers of Guilin Veirun Medical Technology Co., Ltd. Thanks for using VRN-A8 ultrasonic scaler. It will bring you the new experiences and conveniences.

This instruction manual is including the latest information when printing. Guilin Veirun Medical Technology Co., Ltd reserves the rights to change the design of the equipment, the technique, fittings the instruction manual and the content of original packing list at any time without notice. If there are some differences between blueprint and real product, take the real product as the norm.

This instruction manual is protected by copyright law. Without any official authorization, any form of duplication, copy or translated into another language is not allowed.

Read the instruction manual originally delivered with each of the components before using this product, and follow the instruction manual to operate. Otherwise, Guilin Veirun Medical Technology Co., Ltd does not take any responsibility for any errors and damage to the product because of violation operation.



**Note: Guilin Veirun Medical Technology Co., Ltd does not promise any implied guarantee to the product special use for merchantability and applicability.**

If you need after-sale service support, please contact with authorization dealer or manufacturer.

## Warning

The device is not suitable for use in the presence of flammable anesthetic mixtures with air or with oxygen or nitrous oxide.

The device requires no calibration.

The device is not repairable and contains no user serviceable parts.

No modification of this equipment is allowed. (3rd Edition)

The user must check that the equipment functions safely and see that it is in proper working condition before being used.

The manufacturer does not require such preventive inspections by other persons.

## 1. Products overview

### 1.1 Overview

VRN-A8 ultrasonic scaler using automatic frequency tracking system, has the function of scaling, periodontal treatment and root canal irrigation, and has the following characteristics:

- With 2 routes of water supply systems, convenient to operate;
- Hydraulic routing is made by the anti-bacteria materials. The clinical fluids, such as hydrogen peroxide, chlorhexidine, sodium hypochlorite can be filled into the automatic water supply system, which can significantly improve the performance of periodontal therapy and root canal irrigation.
- The handpiece can be autoclaved under high temperature of 135°C and high pressure of 0.22MPa.
- Automatic frequency tracking system ensures the best working status, performance is much more stable.
- The built-in PC chip with intelligent control of power make the treatment more comfortable.
- The evolutionary wireless foot switch remotes the main unit, and the cord switch can also be selected according to user needs.
- High brightness LED light improves the clinical efficiency; the main unit can also fit the regular detachable handpiece.

### 1.2 Product components

The device is composed of electronic controlling circuit, water way, handpiece and tips.

### 1.3 Product scope

The device is used for the dental calculus elimination and root canal irrigation.

### 1.4 The technical specification

- Working conditions:
  - Temperature :5°C~40°C Relative humidity:≤80% Atmospheric pressure : 75KPa~106KPa
- Power supply :
  - For AC adapter: 100-240Vac, 50-60Hz, 1.2A Max.
  - Output: 30Vdc, 1.3A
  - For main unit: 30Vdc, 1.3A
- Wireless control foot pedal battery: 1.5V X 2
- Receiving sensitivity: -114dB
- Primary vibration excursion of the tip: Minimum, 1 μ m, Deviation -50%  
Maximum, 100 μ m, Deviation +50%
- Output half-excursion: Minimum, 0.1N, Deviation -50%  
Maximum, 2N, Deviation +50%
- Vibration frequency of the tip: 25~31KHz
- Input power: 30VA~ 48VA
- Ultrasonic output power: 3W~20W

- Fuse: 125V 1.5A
- Water pressure: 0.1bar~5bar ( 0.01MPa~0.5MPa )
- Weight of main unit: 0.75kg
- Weight of adapter: 0.25kg
- Size: 230mm x 155mm x 56mm
- Operating mode: Continuous operation
- Type of protection against electric shock: Class II equipment
- Degree of protection against electric shock: Type BF applied part
- Degree of protection against harmful ingress of water: Ordinary equipment ( IPX4 ) ,  
Protection degree against water(used on the wireless control foot pedal): ( IPX6 )
- Safety degree of the application in the presence of a Flammable Anaesthetic Mixture with air or with Oxygen or Nitrous Oxide: Equipment not suitable for being used in the presence of a flammable anaesthetic mixture with air or with oxygen or nitrous oxide

## 1.5 Components and function

### 1.5.1 Install Instruction

a ) The front and back sketch map of the main unit

FIGURE 1

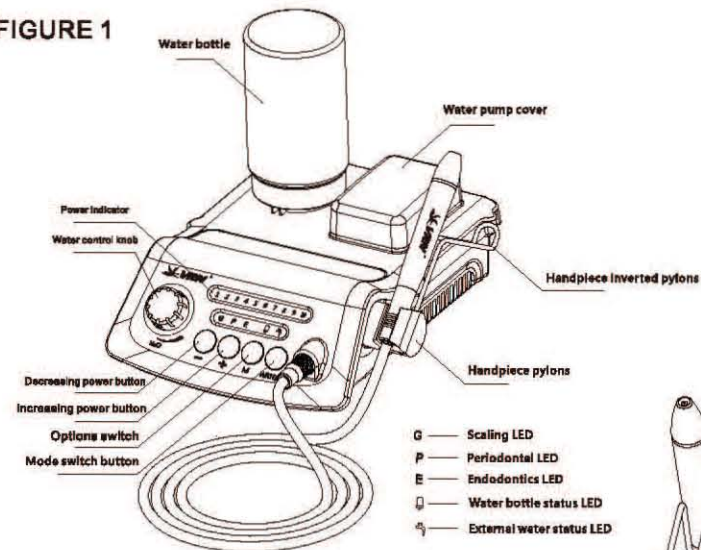
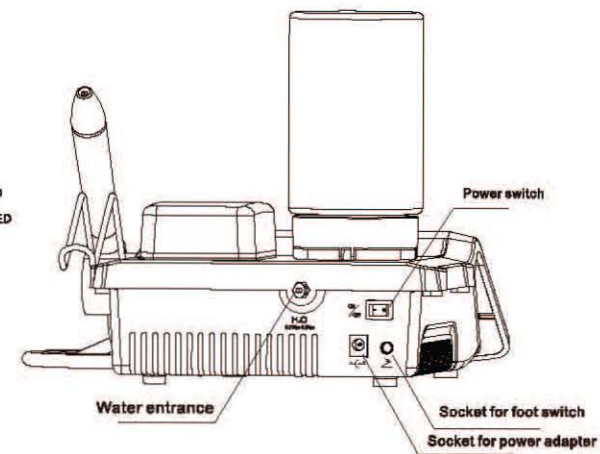

FIGURE 2



b ) Main unit, foot switch and adapter connection

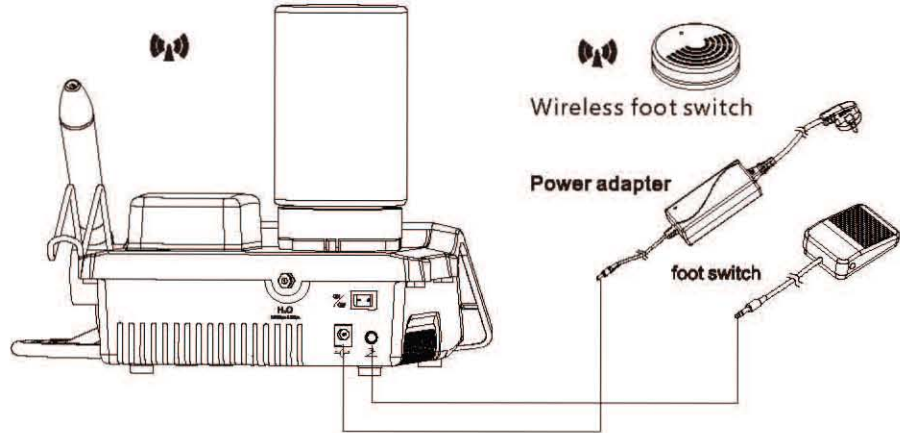

FIGURE 3

c ) Water way connection



FIGURE 4

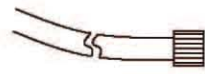

FIGURE 5

d) Detachable handpiece connection (LED Handpiece or Standard Handpiece)

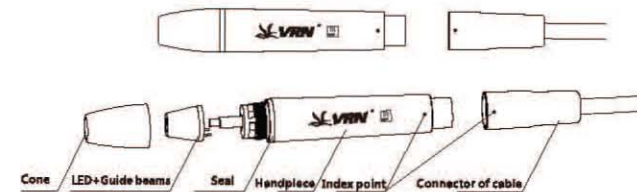

FIGURE 8

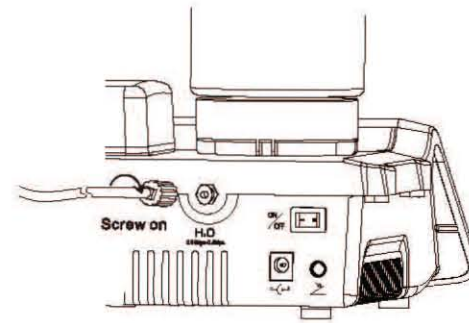
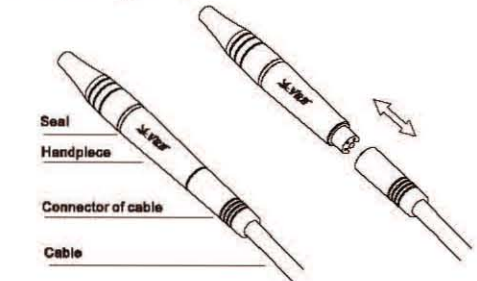

FIGURE 6

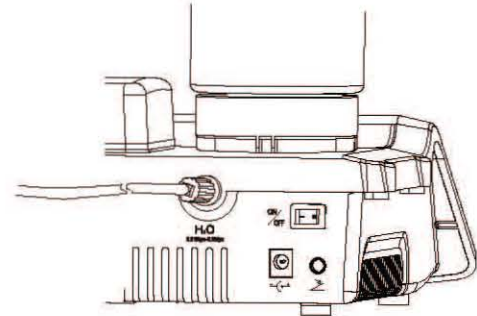

FIGURE 7

e) Installation of tip and endochuck with wrench

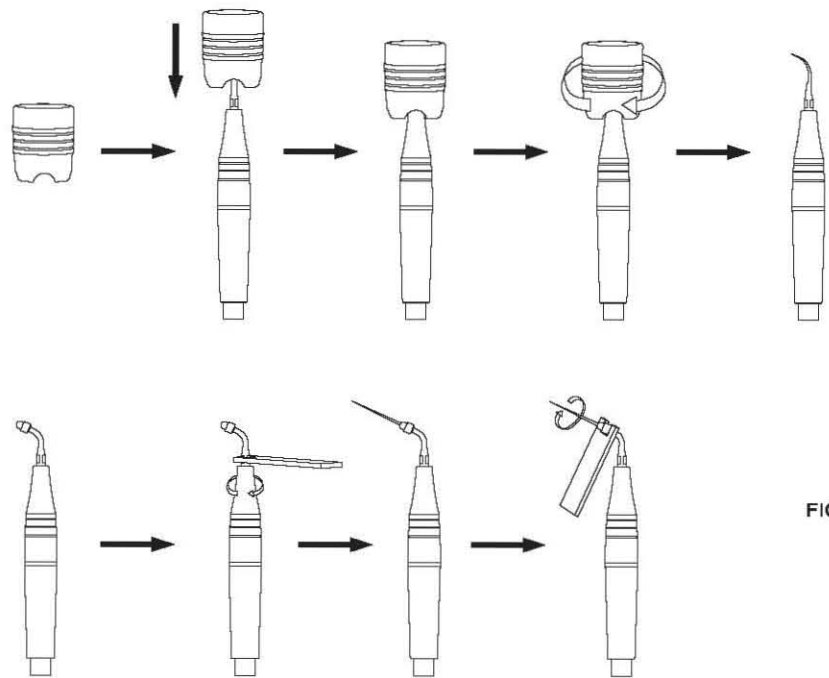

FIGURE 9

f) Installation for the battery of wireless control foot switch

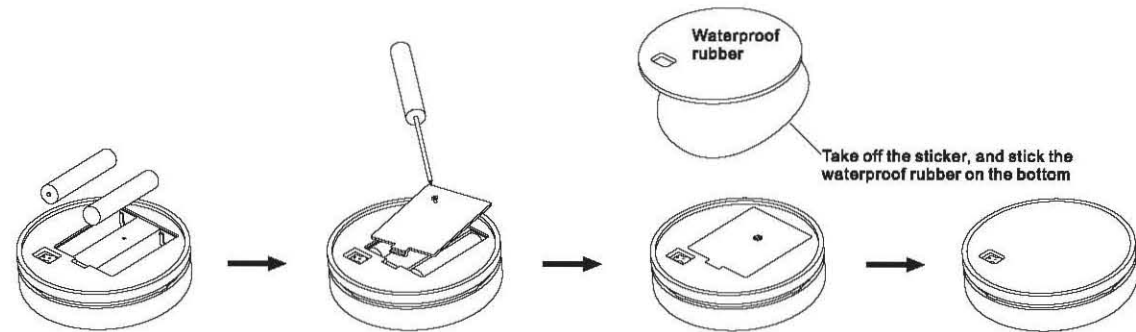
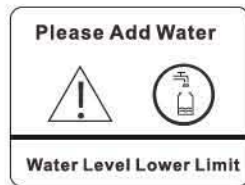
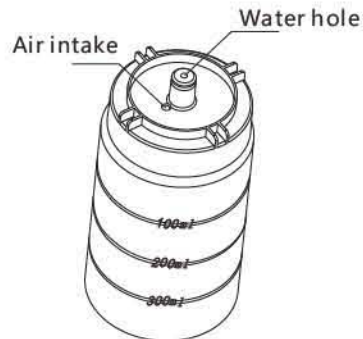
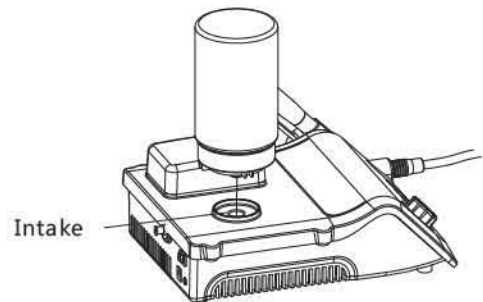

FIGURE 10

g ) Water bottle installation



- 1 Fill up the water or clinical fluids, then tighten the cap
- 2 Insert the water bottle



3 OK!

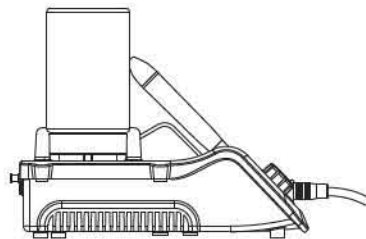

2. Production function and operation

2.1 Scaling function

2.1.1 Operation

- 1) After opening the pack, check that whether the parts and accessories are complete according to the packing list. Take the main unit out of the box and put it on a stable plane.
- 2) Turn the water control knob to the maximum based on symbol as shown (see 3.5.2 [note] 1)
- 3) Install the battery for wireless control foot switch, or insert the plug of the cord foot switch into the main unit. (Figure 8, Figure 3)

Liquid route installation:

- Automatic water supply  
Fill up appropriate amount of purified water into the water bottle, and then insert the water bottle to the main unit.
  - External water supply  
Connect one end of the water tube to the water entrance, and the other end to the purified water source, which can be the dental unit or other water source. (Figure 4)
- 4) Screw the scaling tip tightly to the handpiece by wrench, and then connect the handpiece and the connector of cable correctly. Before the installation of handpiece, please make sure the end of handpiece and the connector of the handpiece are dry.
  - 5) Make sure that the power switch on the main unit is off. Insert the plug of the power source to the main unit, and then connect the power.
  - 6) Turn on the power switch of the main unit, and the function indicator and first four power indicators are on.
  - 7) Choose the automatic water supply or external water supply as need.

- 8)The normal frequency is extremely high. At the normal working state of the scaling tip, a light touch and a certain to-and-fro motion will eliminate the tartar without heating. Overexertion and long-time lingering are forbidden.
- 9)Vibrating intensity: Adjust the vibration intensity as need; generally the middle grade is suitable for most of time. According to patient's different sensitivity and the rigidity of the tartar, adjust the vibrating intensity during the clinical treatment.
- 10)Water volume adjust: Step on the foot switch, and the tip begins to vibrate, and then turn the water control knob to form fine spray to cool down the handpiece and clean the teeth.
- 11)The handpiece can be handled in the same gesture as a pen in hand.
- 12)During the clinical treatment, be sure not to make the end of tip touch the teeth vertically and not to make the tip overexert on the surface of the teeth in case of hurting the teeth and damaging the tip.
- 13)After finishing operation, keep the device working for 30 seconds on the water supply condition in order to clean the handpiece and the scaling tip.
- 14)Unscrew the scaling tip and pull out the handpiece, then sterilize them.



**Notice: Do not pull out the handpiece when the foot switch is stepped on and the device is producing ultrasonic vibration.**

**Please uninstall the battery if not using the wireless control foot pedal for long time.**

#### **2.1.2 Instruction for main components of detachable handpiece ( See figure 8 )**

Seal: Could be cleaned by alcohol

Handpiece: The main part of the whole handpiece can be autoclaved under the high temperature and pressure.

The connector of the cable: Connect the handpiece with the water source and power supply of the main unit.

Notice: Keep dry when the detachable handpiece connects to the connector of the cable.

#### **2.1.3 Instruction of wrench using ( See figure 9 )**

The wrench's structure is designed in special way which can control the strength of the scaling tip's installation properly and correctly. It also can guarantee the operator screw or unscrew the scaling tip effectively and keep their hands away from being scratched.

Operation step:

1)Align the legs of the wrench to the tip.

2)Install the tip: Grip the handle, rotate the tip in a clockwise direction till the tip does not turn round anymore, and then it is installed.

- 3) Unloading the tip: Grip the handle and rotate the tip in a counter-clockwise direction by wrench to remove it.
- 4) Once after using, please put the wrench into disinfection cabinet to disinfect.
- 5) After disinfection, the surface temperature of the wrench is too high to be used again, so user must wait until it is cool down, for avoiding hurt.
- 6) When do not use please put the wrench in a cool, dry and ventilated place, and keep it clean.

## 2.2 Endodontics function

Operation step:

- 1) Fix endochuck to handpiece by endo wrench.
- 2) Unscrew the screw cap on the endochuck.
- 3) Put the ultrasonic file into the hole in the front of endochuck.
- 4) Screw the screw cap with endo wrench to tight up the ultrasonic file.
- 5) Press the function button, turn to endo function
- 6) When ultrasonic scaler is on endo function, only function indicator and first power indicator are bright.  
Put the ultrasonic file into the patient' s root canal slowly, and step on the foot pedal to start endo irrigation.  
During the treatment, turn up the power gradually according to the needs.



**Notice:**

- 1) When fixing endochuck, it must be screwed down.
- 2) The screw cap on the endochuck must be screwed down.
- 3) Do not press it too much when the ultrasonic file in root canal.
- 4) Do not step on the foot pedal until the ultrasonic file is in root canal.
- 5) The power range of endo treatment is advised from the 1st to the 5th grade.

## 2.3 Wireless control foot switch function

### 2.3.1 Installation

Put 2 AA batteries into wireless control foot switch, stick the waterproof rubber on the bottom after covering the battery cover.

Leave the wireless control foot switch on the flat ground.

After installing the ultrasonic scaler, turn on the ultrasonic scaler power.

The wireless control foot switch will identify to the main unit automatically.

### 2.3.2 Usable range

Within any distance of 5 meters, the wireless control foot switch could fully operate the ultrasonic scaler vibrating.

## 2.4 Automatic water supply system

### 2.4.1 Operation

- 1) Open the water cap, fill up the purified water, and then tighten the water cap.
- 2) Clean the water hole of the water bottle and the intake of the main unit.
- 3) Insert the water bottle to the main unit.
- 4) Press the model switch button "WATER" to choose the automatic water supply.

### 2.3.2 Notice

- 1) Make sure the air intake and water hole of the water bottle is not blocked.
- 2) Check the water proof "O-ring" on the water hole part is not damaged. If the "O-ring" is damaged or falling, please replace it immediately.
- 3) Make sure that the water cap is tighten incase of water leaking.
- 4) Clean the water hole of the water bottle before each use.
- 5) When change the liquid inside of water bottle, please turn the water control knob to the maximum and run the device for 30 seconds in order to maintain and clean the current liquid route. Then start to do the treatment.
- 6) When the liquid inside the water bottle is low, please fill up the liquid to ensure the regular working.

## 3. Sterilization and maintenance

- The maintenance and disinfection are operated by the user. The main unit of scaler can be cleaned every half month, and the handpiece, scaler tips and wrench must be autoclaved under high temperature and pressure after each treatment so that it could ensure the safety.
- For usual troubleshooting, please see 3.5, 3.6, quality issue of handpiece and circuit must be maintained by the authorized service party. If the fault still can not be sloved, please contact the local distributors or VRN.

### 3.1 Sterilization of detachable handpiece

#### 3.1.1 Autoclaved under high temperature/pressure:

- 1)121°C/1bar(0.1MPa) 20 minutes
- 2)135°C/2.2bar(0.22MPa) 15 minutes
- 3)Pull out the handpiece and unscrew the scaling tip and endochuck after each operation.
- 4)Pack the handpiece with sterile gauze or sterile bag before sterilizing.
- 5)Reuse handpiece after it cools naturally in case of scalding hand.



#### Notice:

- 1)**Dry the cleaning liquid in the handpiece with compressed air before sterilization.**
- 2)**Be sure that the scaling tip has been unscrewed from the handpiece and it cannot be sterilized with others.**
- 3)**Please check whether the outer of the handpiece is damaged during the irrigation or sterilization, and do not apply any protective oil on the surface of handpiece.**
- 4)**There are 2 waterproof O-ring at the end of handpiece. Since sterilization and repeated pulling**

and inserting will reduce its using life, please lubricate them with dental lube frequently.

Change the new O- ring if it is damaged or worn excessively.

5)The sterilizable parts can be sterilized over 250 times.

6)The following sterilizing methods are forbidden:

- Put handpiece into any liquid for boiling;
- Dip handpiece in disinfectors such as iodine, alcohol and glutaraldehyde;
- Put handpiece into oven or microwave oven for baking.

### 3.2 Sterilization of tips and endochuck

All the scaling tips and endochuck can be autoclaved under high temperature and pressure.

### 3.3 Sterilization of wrench and endo wrench

1)The wrench and endo wrench can be sterilized under high temperature and pressure.

2)The following sterilization methods for wrench are forbidden:

- Braise in liquor;
- Dip in iodine, alcohol or glutaraldehyde;
- Torrefy in oven or microwave oven



#### Notice:

**We are not responsible for any damage of the torque wrench directly or indirectly made by any way in the above items.**

### 3.4 Clean of tips, endochuck, wrench and endo wrench

The scaling tip, endochuck, wrench and endo wrench can be cleaned by ultrasonic cleaner.

### 3.5 Troubleshooting and notes

#### 3.5.1 Troubleshooting

Fault	Possible cause	Solutions
The scaling tip doesn't vibrate and there is no water flowing out when stepping on the foot <b>Switch</b>	The power plug is in loose contact	Make the plug insert to the socket well
	The foot pedal is in loose contact ( wire foot <b>Switch</b> )	Insert the foot switch to its socket tightly
	The fuse in the main unit is broken	Contact the dealers or us
	The battery for wireless control foot <b>Switch</b> died	Change the new batteries
The scaling tip does not vibrate but there is water flowing out when stepping on the foot <b>Switch</b>	The tip is in loose contact	Screw the tip on the handpiece tightly
	The connect plug between the handpiece and the circuit board is in loose contact	Contact the dealer or us
	Handpiece problem	Send the handpiece to dealer or us to repair
	Cable problem	Contact the dealer or us
The scaling tip vibrates but there is no spray when stepping on the foot <b>Switch</b>	The water control knob is not on	Turn on the water control knob <b>[note 1]</b>
	There is impurity in the electric-magnetic valve	Take the electric-magnetic valve apart or contact the dealer or us
	The water system is blocked	Clean the water pipe by multi-function syringe <b>[note 2]</b>
There is still water flowing out after the power is off	The electric-magnetic valve problem	Contact the dealer or us
The handpiece generates heat	The water control knob is in a low setting	Turn the water control knob to a higher grade <b>[note 1]</b>

Fault	Possible cause	Solutions
The amount of spouting water is too little	The water control knob is in a low setting	Turn the water control knob to a higher grade 【note 1】
	The water pressure is not high enough	Make the water pressure higher
	The water system is blocked	Clean the water pipe by multi-function syringe 【note 2】
The vibration of the tip becomes weak	The tip has not been screwed on to the handpiece tightly	Screw the tip tightly
	The coupling between the handpiece and the cable is not dry	Dry it by the hot air
	The tip is damaged 【note 3】	Change the new scaling tip
There is water leaking from the coupling between the handpiece and the cable	The waterproof <b>O-ring</b> is damaged	Change the new waterproof <b>O-ring</b>
The U-file does not vibrate	The screw is loose	Tighten it
	Endochuck is damaged	Change the new endochuck
There is noise coming from the endochuck	The screw is loose	Tighten it
<b>Handpiece no water coming (water supply mode)</b>	Liquid Road tube full of air	<b>Screw water valve to maximum, and reinsert automatic water bottles</b>
LED does not light	Poor contact	Check circuit
	LED burn out	Replacing the LED
	LED wrong installation	LED "+" matches the handpiece "+" tag



**Notice:**

**If the problem still cannot be solved, please contact with local dealer or manufacturer.**

**3.5.2 Notes**

【note 1】

Turn the water control knob as symbol showed. It comes to the min, on the contrary direction, it comes to the max.

【note 2】

1)Clean the water pipe with the multi-function syringe of the dental unit (see figure 10);

2)Disconnect the water pipe from main unit;

3)Get through to the power and turn on the power switch;

4)Connect the multi-function syringe of dental unit to the water pipe;

5)Disassemble the tip or handpiece;

6)Step on the foot switch;

7)Turn on the switch of the multi-function syringe, press the water into the machine and the impurity blocked in the water pipe can be eliminated.

【note 3】 If the scaling tip has been screwed on tightly and there is fine spray too, the following phenomena show that the scaling tip is damaged:

- 1) The vibration of tip and the spray from the tip are apparently weakening.
- 2) The noise or droning sound from tip when operation.

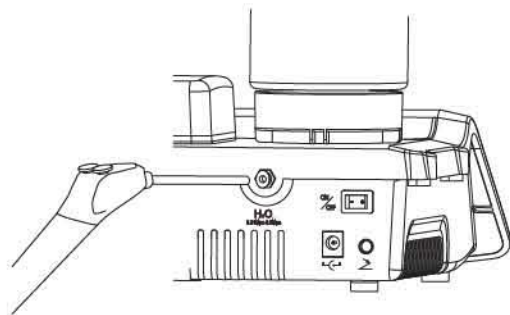

multi-function syringe

FIGURE 11

### 3.6 Troubleshooting for the electric-magnetic valve

If the water is not clean or the electric-magnetic valve works too long, there will be the scale and impurity generated on the inside wall and valve plug. It will cause the water way to be blocked, and could repair as following steps:

- 1) Follow the [ note 2 ]
- 2) Uninstall the electric-magnetic valve by following steps:
  - a) Turn off the power, and unplug the power cable;
  - b) Unscrew the cap, and move out the hood of main unit;

- c) Unscrew the cap on the electric-magnetic valve, and Uninstall the electric-magnetic valve as shown on Figure 11;
- d) Take out the valve plug, and clean out the impurity on the inside wall;
- e) Install the parts as shown on the figure 11.
- f) Ensure the water way is working by repeat [ note 2 ]

## 4. Precaution

### 4.1 Notice when using equipment

- 1) Keep the scaler clean before and after operation.
- 2) The handpiece, scaling tip, wrench, endo wrench and endochuck must be sterilized before each treatment.
- 3) Do not screw or unscrew the scaling tip and endochuck when stepping on the foot switch.
- 4) The scaling tip must be fastened and there must be fine spray or drip coming out from the tip when operation.
- 5) Change a new one when the tip and ultrasonic file are damaged or worn excessively.
- 6) Do not twist or rub the tip and endochuck.
- 7) If use the water source without hydraulic pressure, the water surface should be 1 meter higher than the head of the patient.

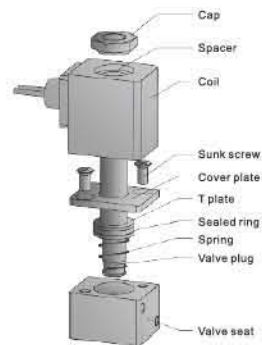

FIGURE 12

8) Ensure the power connection is firm before installing the device; otherwise it could cause the device disfunction.

9) Do not pull the cable forcibly in case of the handpiece falling off from the cable.

10) Do not knock or rub the handpiece.

11) After operation, turn off power, and unplug the power cable.

12) We are only responsible for the safety on the following conditions:

- The maintenance, repair and modification are made by the manufacturer or the authorized dealer.
- The spare components are original of "VRN" and are operated according to instruction manual.

13) The internal screw thread of the scaling tips produced by some manufacturers may be coarse, rusty and collapsed.

This will damage the external screw thread of the handpiece irretrievably.

14) This model only matches the adapter of our company.

- 15 ) The Ultrasonic Scaler only by professional and technical qualifications of doctors to operate.
- 16 ) Ultrasonic Scaler use when away from strong electromagnetic interference devices.
- 17 ) Appliance coupler is considered as disconnect device, please do not place the equipment in a difficultly operation position.

18) Schematic:

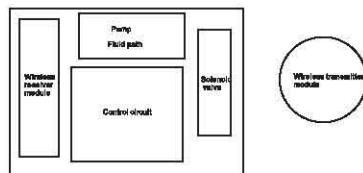

## 4.2 Contraindication

- The hemophilia disease patient is not allowed to use this device.
- The patients or doctors with heart pacemaker are forbidden to use this device.
- The heart disease patient, pregnant woman and children should be cautions to use the device.

## 4.3 Storage and maintenance

- The device should be handled carefully and lightly. Be sure that it is far from the vibration, and installed or kept in a cool, dry and ventilated place.
- Do not store the machine together with the articles that are combustible, poisonous, caustic, and explosive.
- This device should be stored in a room where the relative humidity is  $\leq 80\%$ , atmospheric pressure is 50kPa to 106kPa, and the temperature is  $-20^{\circ}\text{C}$  to  $+50^{\circ}\text{C}$ .
- If not use for a long time, please make the machine get through to the power and water once per month for five minutes.

## 4.4 Transportation

- Excessive impact and shake should be prevented in transportation. Lay it carefully and lightly and do not invert it.
- Do not put it together with dangerous goods during transportation.
- Avoid solarization and getting wet in rain or snow during transportation

## 5. Packing list

No.	Name	Specification/Model
1	Motherboard	/
2	Control panel	/
3	Detachable handpiece	/
4	Handpiece cable	BL-1
5	Tips	5 Tips
6	Wrench	/
7	Endo wrench	/
8	Handpiece seal	
9	Waterproof "O" ring	3.5mm X 1.5mm
10	multi-function syringe	/
11	Water pipe	4mm X 6mm
12	Power adapter	30V
13	electric-magnetic valve	/
14	Wireless control foot switch	/
15	Wired foot switch(option)	/
16	LED	

**Note:** This instruction manual did not detail the specification parts of ultrasonic scaler; please check the promotion documents and "packing list" along with the packing.





















## 6. After service

According to the warranty card, we offer the life time repair since the product is purchased.

The repair of the device should be carried out by our professional technician.

We are not responsible for any irretrievable damage caused by the non-professional person.

## 7. Symbol instruction

	Manufacturer's logo		Caution! Read the operation instruction		Class II equipment		Applied part, type BF
	Disposal		Manufacturer		Used indoor only		Serial number
	Autoclavable		Storage Humidity		Storage Temp		Keep dry
	Fragile		Refer to instruction manual / booklet		Authorised representative in the European community		CE marking: refers to directive 93/42 EEC, including EN60601-1 and EN60601-1-2
	Electrical Outlet		Foot switch connection		Water supply		Power Switch
IPX4	Waterproof grade is splash proof	IPX6	Waterproof rating of water resistance		Production date		

**8. Environmental Protection**

No harmful factor in this product, and deal with it based on the local regulation.

**9. Manufacturer 's right**

We reserve the rights to change the design of the equipment, the technique, fittings the instruction manual and the content of original packing list at any time without notice. If there are some differences between blueprint and real device, take the real device as the norm.

**10. EMC Declaration**

Guidance and manufacturer's declaration – electromagnetic emission –  
for all EQUIPMENT AND SYSTEMS

1	Guidance and manufacturer's declaration – electromagnetic emission		
2	The VRN-A8 Ultrasonic Scaler is intended for use in the electromagnetic environment specified below. The customer or the user of VRN-A8 Ultrasonic Scaler should assure that it is used in such an environment.		
3	Emissions test	Compliance	Electromagnetic environment - guidance
4	RF emissions EN 55011	Group 1	The VRN-A8 Ultrasonic Scaler uses RF energy only for its internal function. Therefore, its RF emissions are very low and are not likely to cause any interference in nearby electronic equipment.  The VRN-A8 Ultrasonic Scaler is suitable for use in all establishments, including domestic establishments and those directly connected to the public low-voltage power supply network that supplies buildings used for domestic purposes.
5	RF emissions EN 55011	Class B	
6	Harmonic emissions EN 61000-3-2	Class A	
7	Voltage fluctuations / flicker emissions EN 61000-3-3	Complies	

**Guidance and manufacturer's declaration – electromagnetic immunity –  
for all EQUIPMENT and SYSTEMS**

<b>Guidance and manufacturer's declaration – electromagnetic immunity</b>			
The VRN-A8 Ultrasonic Scaler is intended for use in the electromagnetic environment specified below. The customer or the user of the VRN-A8 Ultrasonic Scaler should assure that it is used in such an environment.			
<b>Immunity test</b>	<b>EN 60601 test level</b>	<b>Compliance level</b>	<b>Electromagnetic environment - guidance</b>
Electrostatic discharge (ESD) EN 61000-4-2	$\pm 6$ kV contact  $\pm 8$ kV air	$\pm 6$ kV contact  $\pm 8$ kV air	Floors should be wood, concrete or ceramic tile. If floors are covered with synthetic material, the relative humidity should be at least 30 %.
Electrostatic transient / burst EN 61000-4-4	$\pm 2$ kV for power supply lines  $\pm 1$ kV for input/output lines	$\pm 2$ kV for power supply lines  $\pm 1$ kV for input/output lines	Mains power quality should be that of a typical commercial or hospital environment.
Surge EN 61000-4-5	$\pm 1$ kV differential mode  $\pm 2$ kV common mode	$\pm 1$ kV differential mode  $\pm 2$ kV common mode	Mains power quality should be that of a typical commercial or hospital environment.

	$< 5\% U_T$ ( $>95\%$ dip in $U_T$ ) for 0.5 cycle	$< 5\% U_T$ ( $>95\%$ dip in $U_T$ ) for 0.5 cycle	Mains power quality should be that of a typical commercial or hospital environment. If the user of the VRN-A8 Ultrasonic Scaler requires continued operation during power mains interruptions, it is recommended that the VRN-A8 Ultrasonic Scaler be powered from an uninterruptible power supply or a battery.
Voltage dips, short interruptions and voltage variations on power supply input lines EN 61000-4-11	$40\% U_T$ ( $60\%$ dip in $U_T$ ) for 5 cycles  $70\% U_T$ ( $30\%$ dip in $U_T$ ) for 25 cycles	$40\% U_T$ ( $60\%$ dip in $U_T$ ) for 5 cycles  $70\% U_T$ ( $30\%$ dip in $U_T$ ) for 25 cycles	
	$< 5\% U_T$ ( $>95\%$ dip in $U_T$ ) for 5 sec	$< 5\% U_T$ ( $>95\%$ dip in $U_T$ ) for 5 sec	
Power frequency (50/60 Hz) magnetic field EN 61000-4-8	3 A/m	3 A/m	Power frequency magnetic fields should be at levels characteristic of a typical location in a typical commercial or hospital environment.
<b>NOTE</b> $U_T$ is the a. c. mains voltage prior to application of the test level.			

**Guidance and manufacturer's declaration – electromagnetic immunity –  
for EQUIPMENT and SYSTEM that are not LIFE-SUPPORTING**

Guidance and manufacturer's declaration – electromagnetic immunity			
The VRN-A8 Ultrasonic Scaler is intended for use in the electromagnetic environment specified below. The customer or the user of the VRN-A8 Ultrasonic Scaler should assure that it is used in such an environment.			
Immunity test	IEC 60601 test level	Compliance level	Electromagnetic environment - guidance
Conducted RF EN 61000-4-6	3 Vrms 150 kHz to 80 MHz	3 V	<p>Portable and mobile RF communications equipment should be used no closer to any part of the VRN-A8 Ultrasonic Scaler, including cables, than the recommended separation distance calculated from the equation applicable to the frequency of the transmitter.</p> <p><b>Recommended separation distance</b></p> $d = \left[ \frac{3.5}{V_1} \right] \sqrt{P}$
Radiated RF EN 61000-4-3	3 V/m 80 MHz to 2.5 GHz	3 V/m	$d = \left[ \frac{3.5}{E_1} \right] \sqrt{P} \quad 80 \text{ MHz to } 800 \text{ MHz}$ $d = \left[ \frac{7}{E_1} \right] \sqrt{P} \quad 800 \text{ MHz to } 2.5 \text{ GHz}$

		<p>where <math>p</math> is the maximum output power rating of the transmitter in watts (W) according to the transmitter manufacturer and <math>d</math> is the recommended separation distance in metres (m).<sup>b</sup></p> <p>Field strengths from fixed RF transmitters, as determined by an electromagnetic site survey,<sup>a</sup> should be less than the compliance level in each frequency range.<sup>b</sup></p> <p>Interference may occur in the vicinity of equipment marked with the following symbol:</p> 
NOTE 1 At 80 MHz and 800 MHz, the higher frequency range applies.		
NOTE 2 These guidelines may not apply in all situations. Electromagnetic is affected by absorption and reflection from structures, objects and people.		
<p><sup>a</sup> Field strengths from fixed transmitters, such as base stations for radio (cellular/cordless) telephones and land mobile radios, amateur radio, AM and FM radio broadcast and TV broadcast cannot be predicted theoretically with accuracy. To assess the electromagnetic environment due to fixed RF transmitters, an electromagnetic site survey should be considered. If the measured field strength in the location in which the VRN-A8 Ultrasonic Scaler is used exceeds the applicable RF compliance level above, the ACU-H2H+ Holmium medical lasers should be observed to verify normal operation. If abnormal performance is observed, additional measures may be necessary, such as reorienting or relocating the VRN-A8 Ultrasonic Scaler.</p> <p><sup>b</sup> Over the frequency range 150 kHz to 80 MHz, field strengths should be less than 3V/m.</p>		

Recommended separation distances between portable and mobile RF communications equipment and the EQUIPMENT or SYSTEM - for EQUIPMENT and SYSTEMS that are not LIFE-SUPPORTING

Recommended separation distances between portable and mobile RF communications equipment and the VRN-A8 UltrasonicScaler			
The VRN-A8 UltrasonicScaler is intended for use in an electromagnetic environment in which radiated RF disturbances are controlled. The customer or the user of the VRN-A8 UltrasonicScaler can help prevent electromagnetic interference by maintaining a minimum distance between portable and mobile RF communications equipment (transmitters) and the VRN-A8 UltrasonicScaler as recommended below, according to the maximum output power of the communications equipment.			
Rated maximum output of transmitter W	Separation distance according to frequency of transmitter in		
	150 kHz to 80 MHz $d = \left[ \frac{3.5}{F_1} \right] \sqrt{P}$	80 MHz to 800 MHz $d = \left[ \frac{3.5}{E_1} \right] \sqrt{P}$	800 MHz to 2.5 GHz $d = \left[ \frac{7}{E_1} \right] \sqrt{P}$
0.01	0.12	0.12	0.23
0.1	0.38	0.38	0.73
1	1.2	1.2	2.3
10	3.8	3.8	7.3
100	12	12	23

For transmitters rated at a maximum output power not listed above the recommended separation distance d in metres (m) can be estimated using the equation applicable to the frequency of the transmitter, where P is the maximum output power rating of the transmitter in watts (W) according to the transmitter manufacturer.

NOTE 1 At 80 MHz and 800 MHz, the separation distance for the higher frequency range applies.

NOTE 2 These guidelines may not apply in all situations. Electromagnetic propagation is affected by absorption and reflection from structures, objects and people.